

Fiche technique

020SMONCP

Bouton tournant à manette, blanc, 3 positions, Cam O, rappel à ressort au centre, protection incolore scellable

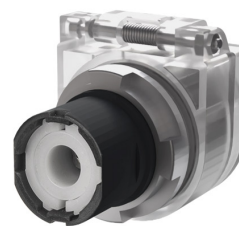

Caractéristiques

Portée	Boutons tournants à manette non-lumineux Ø 22
Composant	3 positions, protection scellable
Code	020SMONCP
Désignation des marchandises	Bouton tournant à manette, blanc, 3 positions, Cam O, rappel à ressort au centre, protection incolore scellable
Couleur	Bianco
Poids	0,0
Tarif douanier	85365080
GTIN	8052878078683

Données techniques

Approvals	CE
Compliance with standards	IEC-EN60947-1, IEC-EN60947-5-1, UL508, CSA C22-2
Compliance with standards	UNI CEI EN 45545-2, CEI EN 61373
Operating temperatures	-40° ÷ +70°C
Environmental operating values	+25°C-97%RH / +45°C-93%RH (IEC-EN60068-2-30)
Protection degree	IP66 - IP69 (IEC-EN60529)
Protection against impact	IK03 (IEC-EN62262)
Mechanical durability	1.000.000 Operations
Shock resistance	30g duration=18ms (EN-IEC 60068-2-27)
Shock resistance	50g duration=11ms (EN-IEC 60068-2-27)
Vibration resistance	5g f= 2...500Hz (EN-IEC 60068-2-6)
Contact blocks configuration	Max no. 8 blocks (4+4)
Material	PA Polyamide
Locking ring material	Zamak zinc alloy
Fixing diameter	22.5mm - Thickness 1÷6mm
Tightening torque	2 ÷ 3Nm (17.7 ÷ 26.6 Lb-in)
Protection against electric shock	Class II (IEC-EN61140)
Sealable guard type	Spring-loaded closure
Sealable guard material	PC Polycarbonate

Sealable guard material - metal components

Stainless steel AISI 304

Warranty period

18 months

Dessins techniques

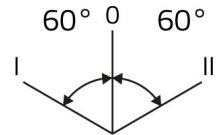
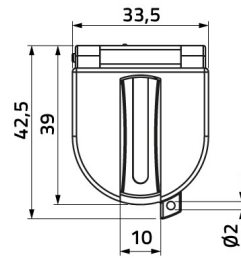
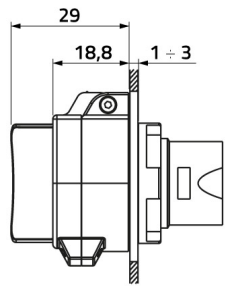
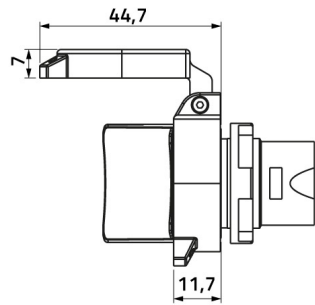
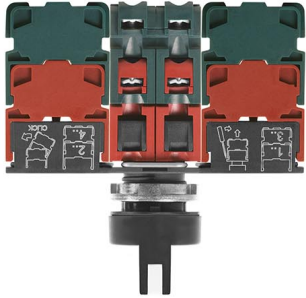
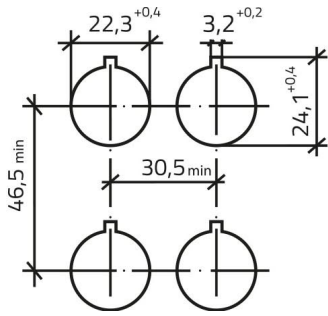

CAM 0

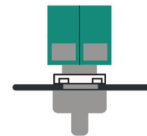
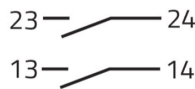
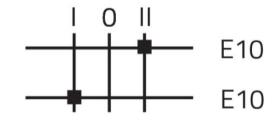
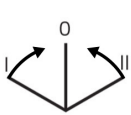

020E10
020E10
020G

CAM 0

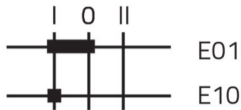
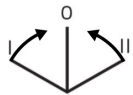

020E01
020E10
020G

CAM 0

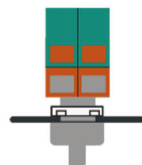
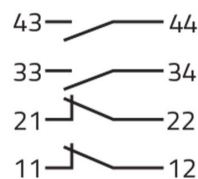
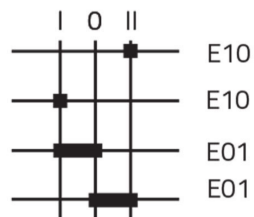
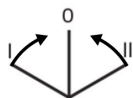

020E01
020E01
020E10
020E10
020G

