

## Datablad

### 020SMONCP

Keuzeknop, wit, 3 posities, Cam O, veerretour naar het midden, Bescherming kleurloos vergrendeling



## Kenmerken

<b>Bereik</b>	Niet-verlichte keuzeknoppen Ø 22
<b>Component</b>	3-positie keuzeknoppen , afsluitbare bescherming
<b>Rubriek</b>	020SMONCP
<b>Omschrijving</b>	Keuzeknop, wit, 3 posities, Cam O, veerretour naar het midden, Bescherming kleurloos vergrendeling
<b>Kleur</b>	Bianco
<b>Gewicht</b>	0,0
<b>Douanetarief</b>	85365080
<b>GTIN</b>	8052878078683

## Technische gegevens

<b>Approvals</b>	CE
<b>Compliance with standards</b>	IEC-EN60947-1, IEC-EN60947-5-1, UL508, CSA C22-2
<b>Compliance with standards</b>	UNI CEI EN 45545-2, CEI EN 61373
<b>Operating temperatures</b>	-40° ÷ +70°C
<b>Environmental operating values</b>	+25°C-97%RH / +45°C-93%RH (IEC-EN60068-2-30)
<b>Protection degree</b>	IP66 - IP69 (IEC-EN60529)
<b>Protection against impact</b>	IK03 (IEC-EN62262)
<b>Mechanical durability</b>	1.000.000 Operations
<b>Shock resistance</b>	30g duration=18ms (EN-IEC 60068-2-27)
<b>Shock resistance</b>	50g duration=11ms (EN-IEC 60068-2-27)
<b>Vibration resistance</b>	5g f= 2...500Hz (EN-IEC 60068-2-6)
<b>Contact blocks configuration</b>	Max no. 8 blocks (4+4)
<b>Material</b>	PA Polyamide
<b>Locking ring material</b>	Zamak zinc alloy
<b>Fixing diameter</b>	22.5mm - Thickness 1÷6mm
<b>Tightening torque</b>	2 ÷ 3Nm (17.7 ÷ 26.6 Lb-in)
<b>Protection against electric shock</b>	Class II (IEC-EN61140)
<b>Sealable guard type</b>	Spring-loaded closure
<b>Sealable guard material</b>	PC Polycarbonate

---

<b>Sealable guard material - metal components</b>	Stainless steel AISI 304
---------------------------------------------------	--------------------------

---

<b>Warranty period</b>	18 months
------------------------	-----------

---

# Technische tekeningen

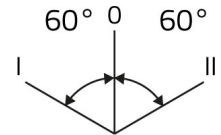
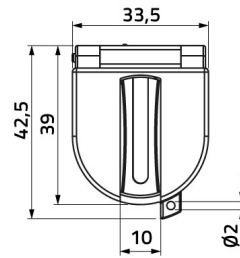
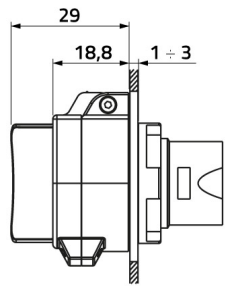
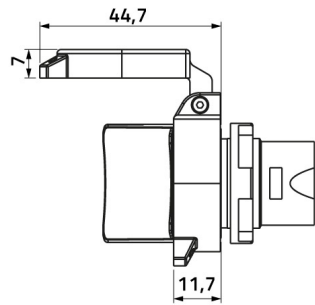
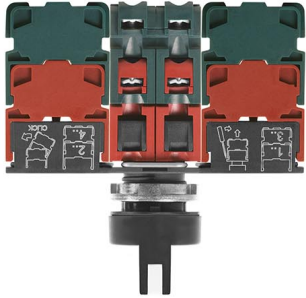
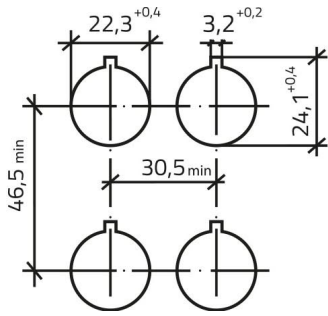

## CAM 0

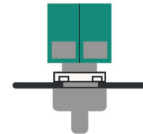
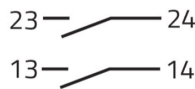
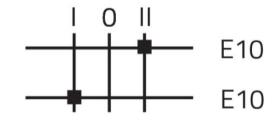
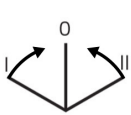

020E10  
020E10  
020G

## CAM 0

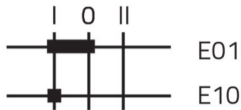
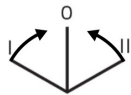

020E01  
020E10  
020G

## CAM 0

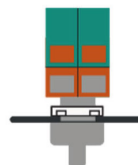
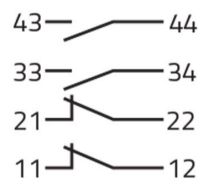
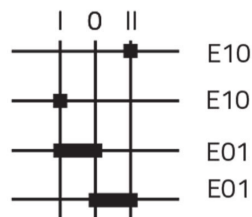
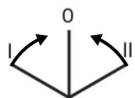

020E01  
020E01  
020E10  
020E10  
020G

