

## Datenblatt

### 020SMTLOBLD

Beleuchteter Drehknopf-Wahlschalter, blau, 3 Positionen, Cam O, Federrücklauf von rechts beleuchtet

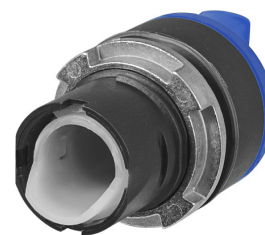

## Merkmale

<b>Baureihe</b>	Beleuchteter Wahlschalter Ø 22
<b>Komponenten</b>	Drehknopf-Wahlschalter, 3 Positionen
<b>Artikel-Nr.</b>	020SMTLOBLD
<b>Beschreibung</b>	Beleuchteter Drehknopf-Wahlschalter, blau, 3 Positionen, Cam O, Federrücklauf von rechts beleuchtet
<b>Farbe</b>	Blu
<b>Gewicht - gr</b>	27,0
<b>Zolltarifnummer</b>	85365080
<b>GTIN</b>	8052878066611

## Technische Daten

<b>Approvals</b>	CE
<b>Compliance with standards</b>	IEC-EN60947-1, IEC-EN60947-5-1, UL508, CSA C22-2
<b>Compliance with standards</b>	UNI CEI EN 45545-2
<b>Operating temperatures</b>	-40° ÷ +70°C
<b>Environmental operating values</b>	+25°C-97%RH / +45°C-93%RH (IEC-EN60068-2-30)
<b>Protection degree</b>	IP65 (IEC-EN60529)
<b>Protection against impact</b>	IK03 (IEC-EN62262)
<b>Mechanical durability</b>	1.000.000 Operations
<b>Shock resistance</b>	30g duration=18ms (EN-IEC 60068-2-27)
<b>Vibration resistance</b>	5g f= 2...500Hz (EN-IEC 60068-2-6)
<b>Contact blocks configuration</b>	Max no. 2 blocks (1+1)
<b>Housing material</b>	PA Polyamide
<b>Knob or lever material</b>	PC Polycarbonate
<b>Locking ring material</b>	Zamak zinc alloy
<b>Fixing diameter</b>	22.5mm - Thickness 1÷6mm
<b>Tightening torque</b>	2 ÷ 3Nm (17.7 ÷ 26.6 Lb-in)
<b>Illuminated selector switch (all versions)</b>	It is mandatory to use LED bulbs type 010BA9SLxxx
<b>Protection against electric shock</b>	Class II (IEC-EN61140)
<b>Warranty period</b>	18 months

# Technische Zeichnungen



## CAM 0



020E10  
020E10  
020G

## CAM 0



020E01  
020E10  
020G

