

## Scheda Dati

### 020STAMLOIWC

Bouton tournant lumineux à manette, incolore, 3 positions, Cam O, rappel à ressort au centre, métal



## Caratteristiche

<b>Portée</b>	Boutons tournants à manette lumineux Ø 22 - collerette mét.
<b>Componente</b>	3 positions
<b>Code</b>	020STAMLOIWC
<b>Désignation des marchandises</b>	Bouton tournant lumineux à manette, incolore, 3 positions, Cam O, rappel à ressort au centre, métal
<b>Couleur</b>	Incolore
<b>Peso</b>	38,0
<b>Tariffa doganale</b>	85365080
<b>GTIN</b>	8052878024802

## Dati tecnici

<b>Approvals</b>	CE
<b>Compliance with standards</b>	IEC-EN60947-1, IEC-EN60947-5-1, UL508, CSA C22-2
<b>Compliance with standards</b>	UNI CEI EN 45545-2
<b>Operating temperatures</b>	-25° ÷ +65°C
<b>Environmental operating values</b>	+25°C-97%RH / +45°C-93%RH (IEC-EN60068-2-30)
<b>Protection degree</b>	IP65 (IEC-EN60529)
<b>Protection against impact</b>	IK03 (IEC-EN62262)
<b>Mechanical durability</b>	1.000.000 Operations
<b>Shock resistance</b>	30g duration=18ms (EN-IEC 60068-2-27)
<b>Shock resistance</b>	50g duration=11ms (EN-IEC 60068-2-27)
<b>Vibration resistance</b>	5g f= 2...500Hz (EN-IEC 60068-2-6)
<b>Contact blocks configuration</b>	Max no. 2 blocks (1+1)
<b>Knob or lever material</b>	PC Polycarbonate
<b>External bezel material</b>	Chromed zinc alloy
<b>Locking ring material</b>	Zamak zinc alloy
<b>Fixing diameter</b>	22.5mm - Thickness 1÷6mm
<b>Tightening torque</b>	2 ÷ 3Nm (17.7 ÷ 26.6 Lb-in)
<b>Illuminated selector switch (all versions)</b>	It is mandatory to use LED bulbs type 010BA9SLxxx
<b>Protection against electric shock</b>	Class II (IEC-EN61140)

---

**Warranty period**

18 months

---

# Disegni tecnici

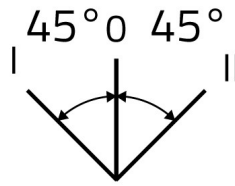
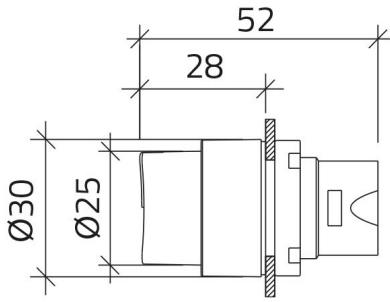

## CAM O

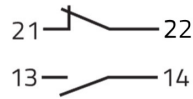
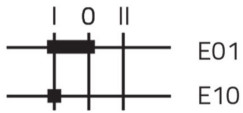
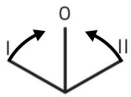

020E01  
020E10  
020G

## CAM O

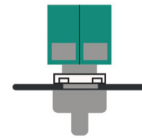
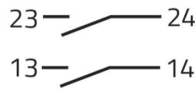
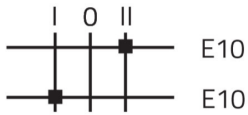
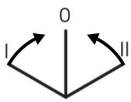

020E10  
020E10  
020G

