

# Datasheet

## 020STAMOVWS

Knob selector switch, green, 3-position, Cam O, spring return from LH, metal



## Features

<b>Range</b>	Non-illuminated knob selector switches Ø 22 - metal bezel
<b>components</b>	3-position
<b>Code</b>	020STAMOVWS
<b>Description</b>	Knob selector switch, green, 3-position, Cam O, spring return from LH, metal
<b>Colour</b>	Verde
<b>Weight - gr</b>	38.0
<b>Customs Tariff</b>	85365080
<b>GTIN</b>	8052878025472

## Datasheet

<b>Approvals</b>	CE
<b>Compliance with standards</b>	IEC-EN60947-1, IEC-EN60947-5-1, UL508, CSA C22-2
<b>Compliance with standards</b>	UNI CEI EN 45545-2
<b>Operating temperatures</b>	-25° ÷ +65°C
<b>Environmental operating values</b>	+25°C-97%RH / +45°C-93%RH (IEC-EN60068-2-30)
<b>Protection degree</b>	IP65 (IEC-EN60529)
<b>Protection against impact</b>	IK03 (IEC-EN62262)
<b>Mechanical durability</b>	1.000.000 Operations
<b>Shock resistance</b>	30g duration=18ms (EN-IEC 60068-2-27)
<b>Shock resistance</b>	50g duration=11ms (EN-IEC 60068-2-27)
<b>Vibration resistance</b>	5g f= 2...500Hz (EN-IEC 60068-2-6)
<b>Contact blocks configuration</b>	Max no. 4 blocks (2+2)
<b>Knob or lever material</b>	PC Polycarbonate
<b>External bezel material</b>	Chromed zinc alloy
<b>Locking ring material</b>	Zamak zinc alloy
<b>Fixing diameter</b>	22.5mm - Thickness 1÷6mm
<b>Tightening torque</b>	2 ÷ 3Nm (17.7 ÷ 26.6 Lb-in)
<b>Protection against electric shock</b>	Class II (IEC-EN61140)
<b>Warranty period</b>	18 months

# Technical drawings



## CAM O



020E10  
020E10  
020G

## CAM O

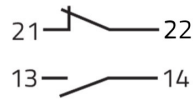
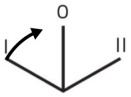

020E01  
020E10  
020G

## CAM O



020E01  
020E01  
020E10  
020E10  
020G

