

## Datablad

020STAMQBLW

Keuzeknop, blauw, 4 posities, Cam Q, metaal



## Kenmerken

<b>Bereik</b>	Niet-verlichte keuzeschakelaars Ø 22 ■ metalen ringmoer
<b>Component</b>	4-positie keuzeknoppen
<b>Rubriek</b>	020STAMQBLW
<b>Omschrijving</b>	Keuzeknop, blauw, 4 posities, Cam Q, metaal
<b>Kleur</b>	Blu
<b>Gewicht</b>	38,0
<b>Douanetarief</b>	85365080
<b>GTIN</b>	8052878025519

## Technische gegevens

<b>Approvals</b>	CE
<b>Compliance with standards</b>	IEC-EN60947-1, IEC-EN60947-5-1, UL508, CSA C22-2
<b>Compliance with standards</b>	UNI CEI EN 45545-2
<b>Operating temperatures</b>	-25° ÷ +65°C
<b>Environmental operating values</b>	+25°C-97%RH / +45°C-93%RH (IEC-EN60068-2-30)
<b>Protection degree</b>	IP65 (IEC-EN60529)
<b>Protection against impact</b>	IK03 (IEC-EN62262)
<b>Mechanical durability</b>	1.000.000 Operations
<b>Shock resistance</b>	30g duration=18ms (EN-IEC 60068-2-27)
<b>Shock resistance</b>	50g duration=11ms (EN-IEC 60068-2-27)
<b>Vibration resistance</b>	5g f= 2...500Hz (EN-IEC 60068-2-6)
<b>Contact blocks configuration</b>	Max no. 4 blocks (2+2)
<b>Knob or lever material</b>	PC Polycarbonate
<b>External bezel material</b>	Chromed zinc alloy
<b>Locking ring material</b>	Zamak zinc alloy
<b>Fixing diameter</b>	22.5mm - Thickness 1÷6mm
<b>Tightening torque</b>	2 ÷ 3Nm (17.7 ÷ 26.6 Lb-in)
<b>Protection against electric shock</b>	Class II (IEC-EN61140)
<b>Warranty period</b>	18 months

# Technische tekeningen



## CAM Q

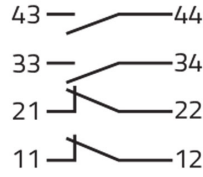

020E10  
020E10  
020E01  
020E01  
020G

